

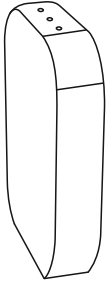

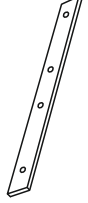

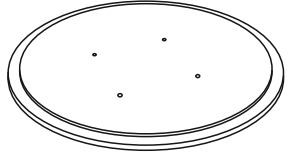

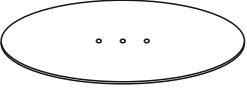



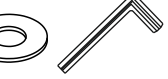

**ITEM NAME/NOM D'ITEM: PEMBA SIDE TABLE**

**ITEM # /NO. ITEM: 109768**

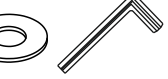
**PARTS LIST/LISTE DES PIÈCES**

<p>(1)</p>  <p>x1</p>	<p>(2)</p>  <p>x2</p>	<p>(3)</p>  <p>x1</p>	<p>(4)</p>  <p>x1</p>	<p>(5)</p> <table border="0"> <tr> <td data-bbox="1005 392 1077 448">A.</td> <td data-bbox="1093 392 1165 448">B.</td> <td data-bbox="1181 392 1252 448">C.</td> <td data-bbox="1268 392 1340 448">D.</td> <td data-bbox="1356 392 1524 448">E.</td> </tr> <tr> <td></td> <td></td> <td></td> <td></td> <td></td> </tr> <tr> <td>11x16mm</td> <td>11x19mm</td> <td>11x1.5mm</td> <td>18x1mm</td> <td>4mm</td> </tr> <tr> <td>x7</td> <td>x4</td> <td>x4</td> <td>x4</td> <td>x1</td> </tr> </table>	A.	B.	C.	D.	E.						11x16mm	11x19mm	11x1.5mm	18x1mm	4mm	x7	x4	x4	x4	x1
A.	B.	C.	D.	E.																				
																								
11x16mm	11x19mm	11x1.5mm	18x1mm	4mm																				
x7	x4	x4	x4	x1																				

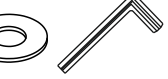
**ASSEMBLY INSTRUCTIONS/INSTRUCTIONS D'ASSEMBLAGE**

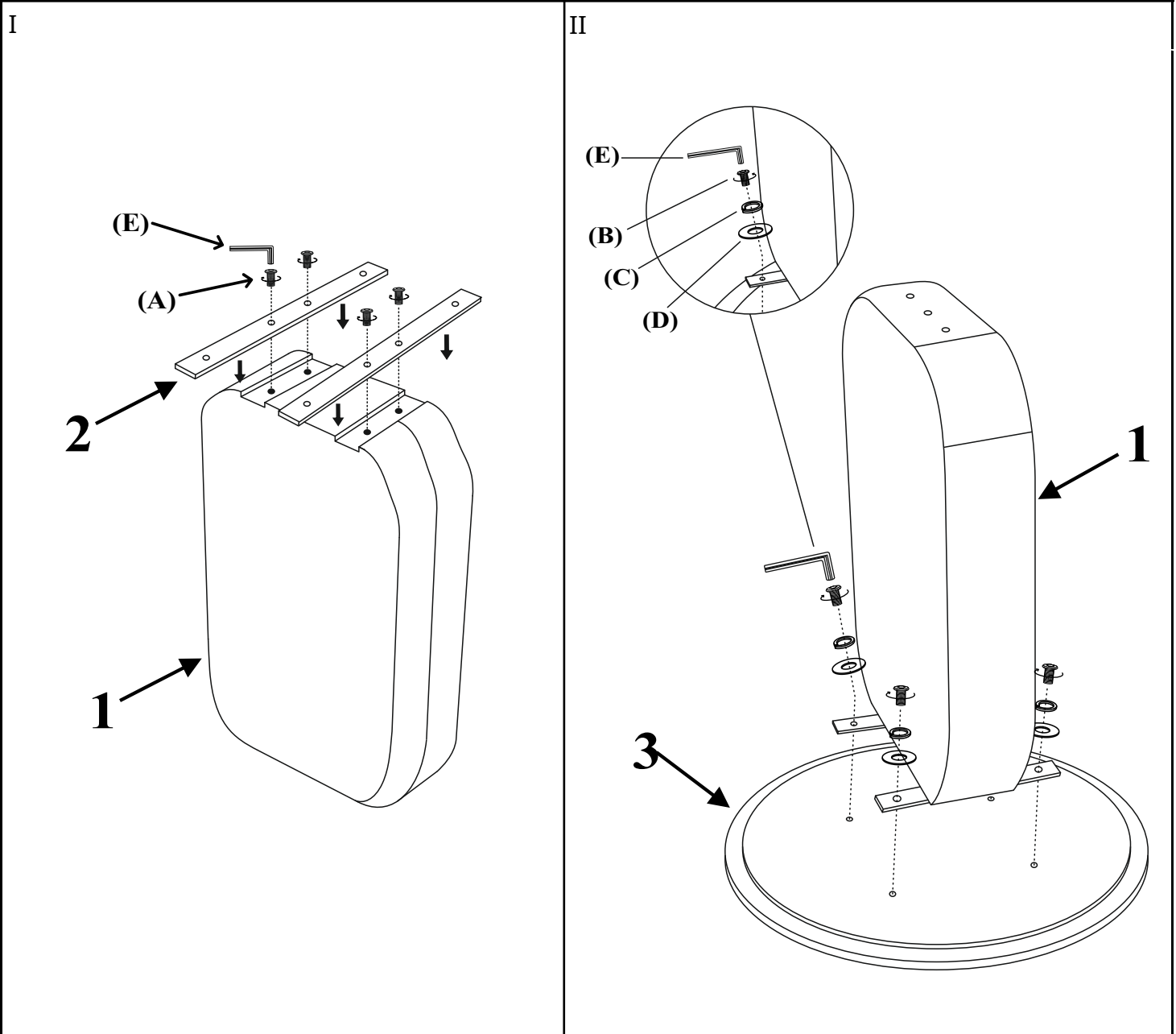

For missing parts or damaged parts, please call /  
 Pour pièce manquante ou endommagée, veuillez appeler:

USA, Canada and Mexico: (866)-798-6663

**ITEM NAME/NOM D'ITEM: PEMBA SIDE TABLE**

**ITEM # /NO. ITEM: 109768**

III

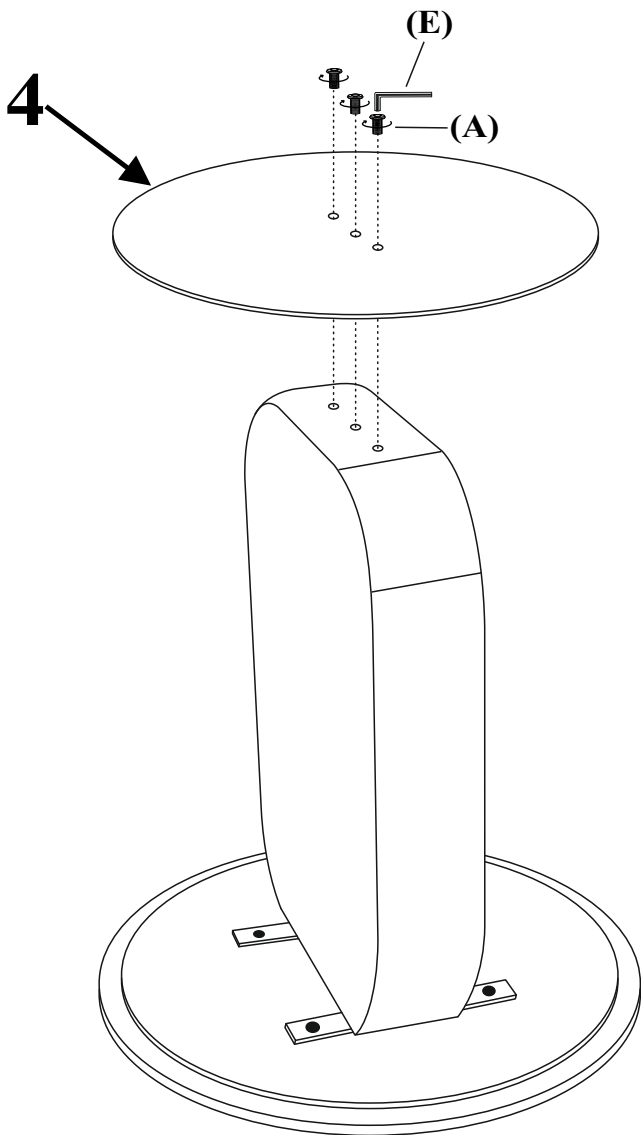

IV

